





# DRILL GUIDE

## INSTRUCTIONS FOR PRINTING DRILL GUIDE

- ⊕ Turret --- drill size is 3/32"
- ⊕ Standoff – drill size to fit
- ⊕ Hole for wire pass thru – drill size to fit
- Dashed lines are underboard jumpers

**NOTE...** This drawing contains layers. Turn off any layers that you don't want to print.

Board size is 3 1/8" X 8 1/2". Print this drill guide FULL SIZE on letter sized paper. Measure the board length of the printout to verify it is 8 1/2". Attach to blank board using double sided carpet tape. Use a center punch to put a mark at the cross hairs of each turret, standoff, and hole. Use a 3/32" drill bit to drill all holes. Then enlarge holes as needed for screws and wire pass thru.

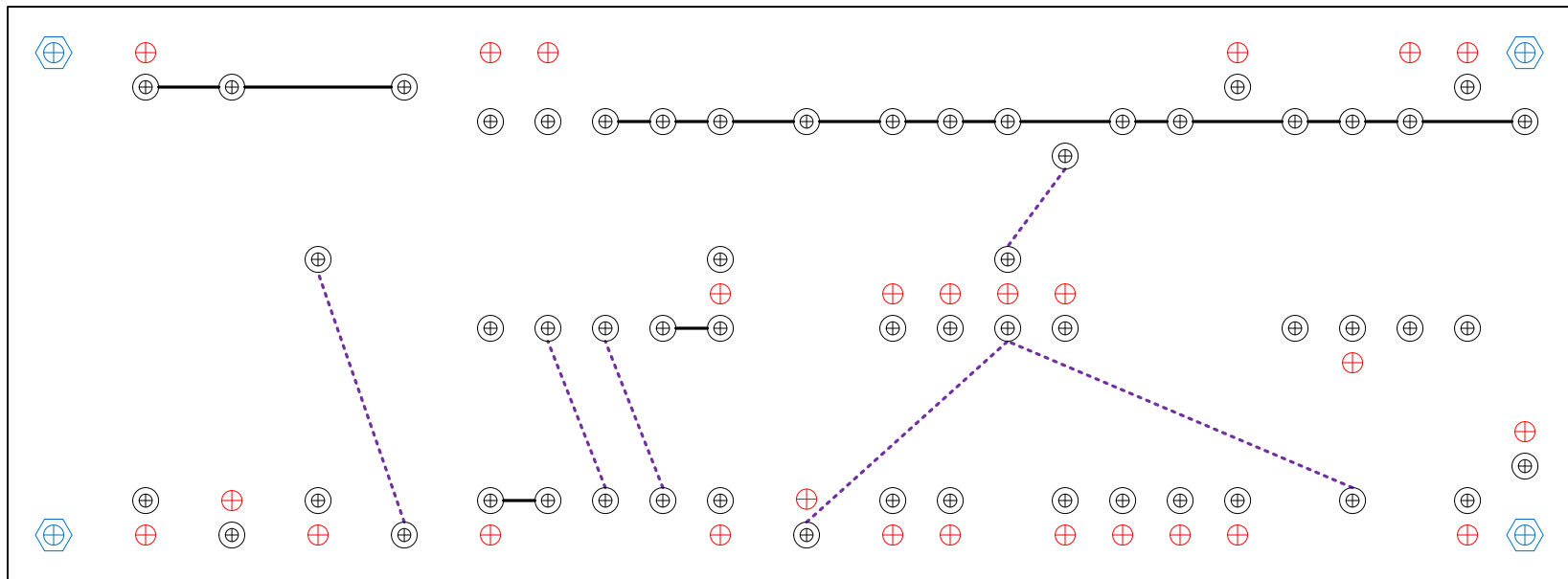

POWER

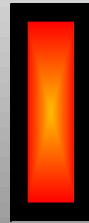

# SUPRO Dual Tone

Model S-6424

FOOTSWITCH



INTENSITY  
Pull ON

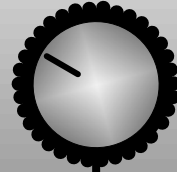

SPEED

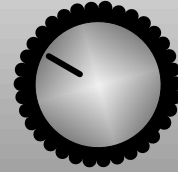

TONE

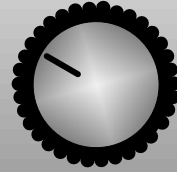

VOLUME

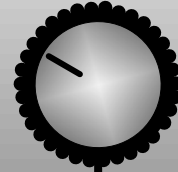

CHANNEL 2

TONE

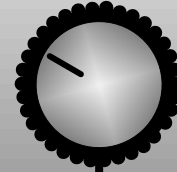

VOLUME

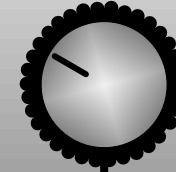

CHANNEL 1

INPUT

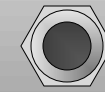

CHANNEL SELECT

1

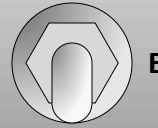

BOTH

2

INSTRUMENT

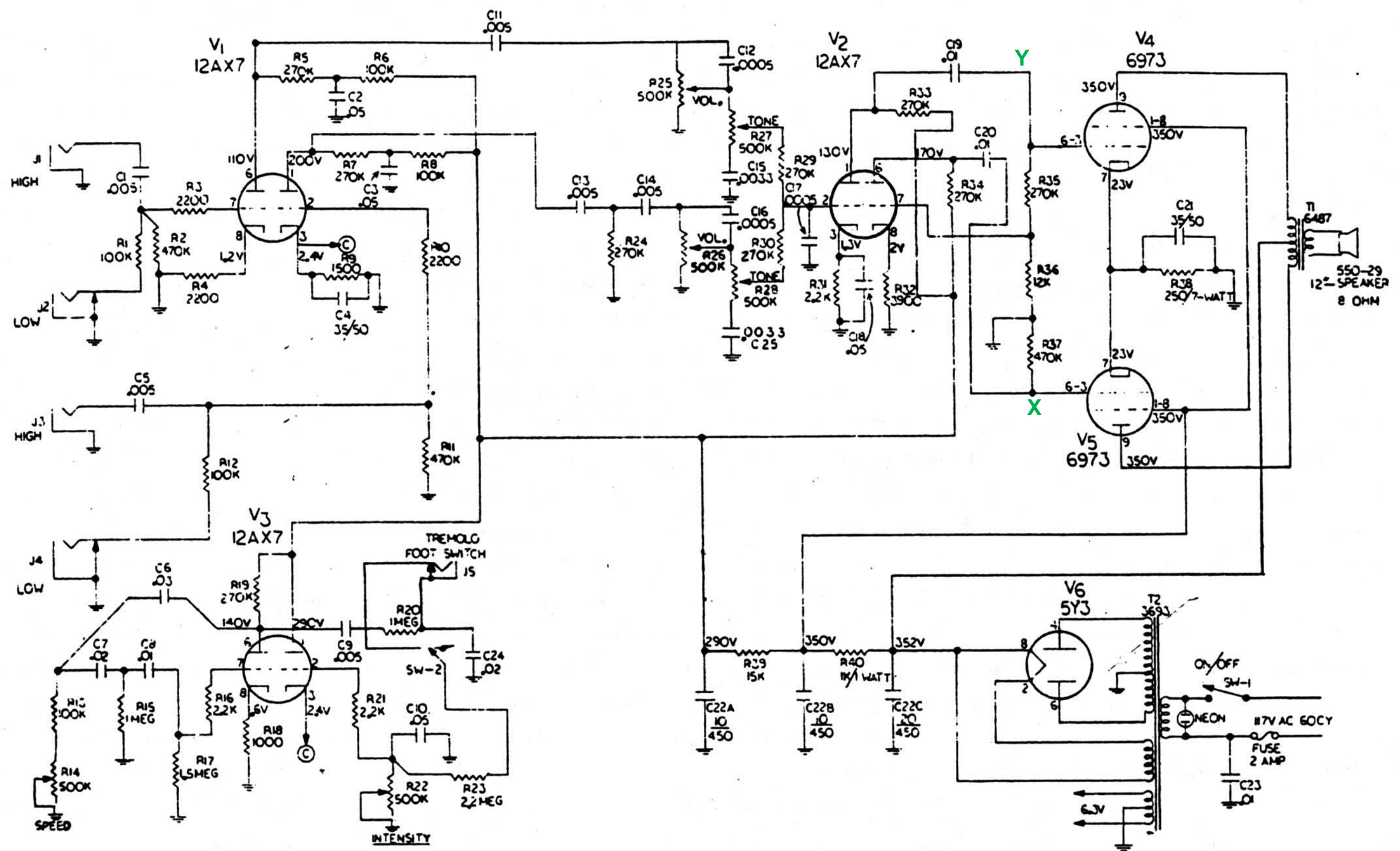

Supro Model S6424

MV Mod... I don't have this mod in my amp and really don't think it's necessary.  
But I know someone will ask, so this is how I would do it.

