

Measuring Output - Transformer Performance

By Menno van der Veen

Introduction

Rickard Berglund recently wrote an interesting article about output-transformer (OPT) tests.¹ As designer of the new wide-bandwidth toroidal output transformers (Plitron PAT-range),^{2,3} I was very happy with this supportive article because of the evaluative tools it provides. I researched Berglund's test methods and found them good and reliable. His article contains some important statements that I believe need extra attention:

"The transformer with the lowest current and the straightest line produces the lowest distortion in the bass" ... "A transformer with high primary inductance does not necessarily mean lower distortion than one with low primary inductance" and "The high-inductance transformer can have a very nonlinear current-to-voltage characteristic."

What does all this mean? What happens in an output transformer? Why and how does it distort the precious audio signals? How do you prevent this distortion? Is it as bad as distortion percentages suggest? To deal with these questions, I will start with the measurement of the secondary inductance.

Secondary-Inductance Measurement

Figure 1 (from Berglund's article) shows the measurement setup. A sine-wave voltage with a frequency of 20Hz or 25Hz is connected over the secondary winding of the OPT.

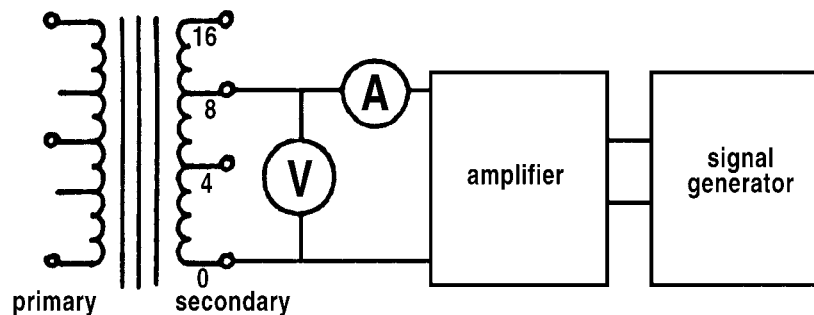

FIGURE 1: Transformer connection for measuring inductance.

Reprinted from Glass Audio 5/97

The voltage v_s is measured, as is the current i_s , through the secondary. There is no load on the primary side of the OPT. Be careful not to touch the primary, for in this measurement, its voltage can become very high.

Berglund's article gave the test results for several samples of OPTs (Table 1), and I assume that these measurements all were done at 20Hz connected to the 8Ω secondary taps. I placed these results in a graph (Fig. 2) and added measurements of the toroidal PAT4006 transformer, done at 25Hz to compensate for the fact that the PAT4006 has a secondary impedance of 5Ω instead of the 8Ω taps Berglund used.

Figure 2 clearly shows that the samples behave differently. The reason lies in the construction and the materials used. The samples with the lowest current have the highest inductance. You can estimate the linearity of the i_s/v_s lines by comparing each characteristic to a straight line. However, the currents were measured only at four voltages, so it is not easy to determine the linearity. For that reason, I measured sample 6 at additional secondary-voltage values (Fig.3).

This graph clearly shows that the i_s/v_s characteristic looks like a straight line over almost the whole range. The conclusion is obvious that it meets the standards outlined in Berglund's article. However, you can determine its linearity more precisely. When this

characteristic is absolutely linear, the division of v_s by i_s for each point of measurement should be a constant number (Fig. 4).

The secondary impedance is large, but shows a clear variation. It is not a horizontal straight line, so it is not absolutely linear. Because of this, I propose to modify Berglund's statements by adding that

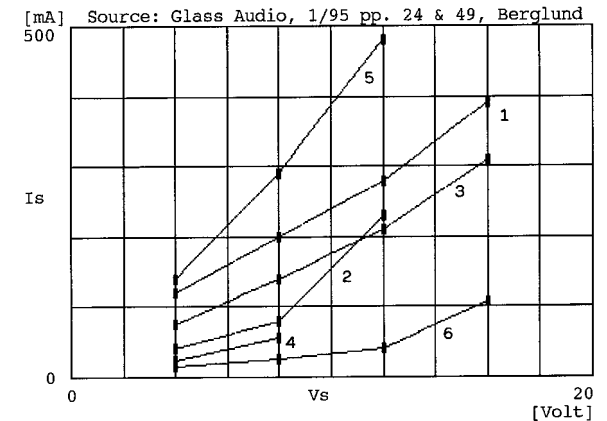

FIGURE 2: Current-voltage characteristics of sample OPTs, numbered as in Table 1.

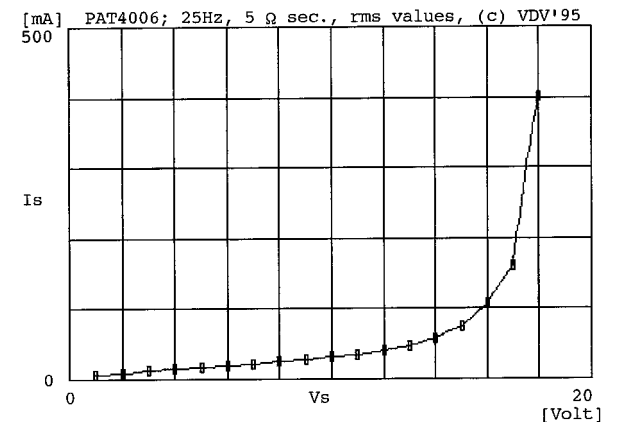

FIGURE 3: Detailed measurements for sample 6.

you test the linearity of an i_s/v_s characteristic by calculating the secondary impedance $Z_s = v_s/i_s$ as a function of v_s .

Calculating the Inductance

What is the cause of the alinearity found in sample 6? To answer that question, you must research the behavior of the core. Figure 4 suggests that an effect exists in the core that

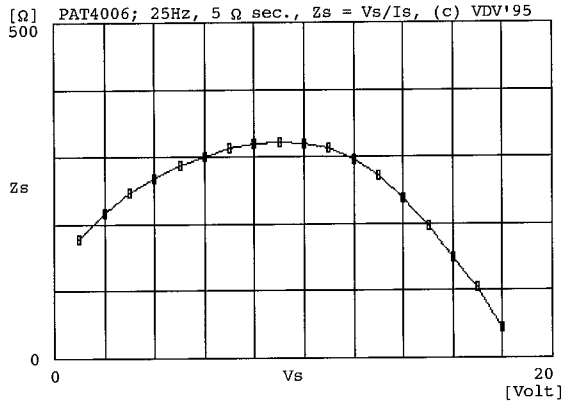

FIGURE 4: Secondary impedance $Z_s = v_s/i_s$ as a function of v_s .

causes the deviation from linearity. I started investigating this effect with the low-frequency equivalent circuit of the output transformer as seen from its secondary side (Fig. 5).

R_{is} is the resistance of the secondary winding. Core losses due to hysteresis and eddy currents in the core are represented by R_c . The third element is the secondary inductance L_s .

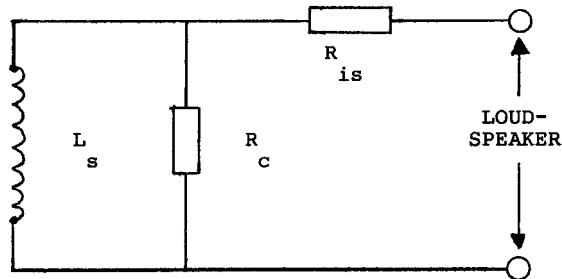

FIGURE 5: Low-frequency equivalent circuit on the OPT secondary side.

To develop a simple but adequate explanation, I disregarded the influence of core losses, which becomes important at high output levels close to core saturation. By staying at a moderate power level, you can disregard R_c in Fig. 5. The relation between v_s and i_s at frequency f is:

$$\frac{v_s}{i_s} = R_{is} + j \times 2\pi f L_s \quad (1)$$

$$(j = \sqrt{-1} \text{ and } \pi = 3.14)$$

You can eliminate the imaginary unit j by calculating the magnitude of v_s/i_s and then finding L_s . Formula 2 shows how:

$$\frac{v_s}{i_s} = \sqrt{R_{is}^2 + (2\pi f L_s)^2} = L_s = \sqrt{\left(\frac{v_s}{i_s}\right)^2 - R_{is}^2} \times \frac{1}{2\pi f} \quad (2)$$

You can find the value of R_{is} by means of a resistance measurement. Because π , f , and all the v_s/i_s measurement points are known, you can calculate the secondary inductance L_s . The results are shown in Fig. 6, while Fig. 7 gives the inductance on the primary side, calculated by $L_p = L_s \times (N_p/N_s)^2$. N_p and N_s are the numbers of primary and secondary turns, respectively.

This calculation clearly shows that L_s is not constant. Because the value of R_{is} is very small ($.18\Omega$), the L_s curve behaves identically with the v_s/i_s graph. Now you can ask the more precise question as to what causes these variations in L_s .

Exploring the Core

When a current passes through the coil around a core, it creates a magnetic field, and the particles (and groups of particles called Weissareas) start to rotate and move (magnetostriction). The more easily they can do so, the stronger the magnetic field generated in the core, since this is influenced by all the Weissareas pointing in the same direction. The ease of movement and the proportion of Weissareas pointing in the same direction are indicated by the relative magnetic permeability, μ_r . The larger μ_r 's value, the better the core reacts upon the magnetic field created by the secondary coil.

All the moving Weissareas create a kind of magnetic interference, resulting in a voltage noise

over the windings. This is called the "Barkhausen effect," and its magnitude depends on the quality of the iron used. An important selection criterion for core material is a low Barkhausen effect. The μ_r is the cause of the alinearity of L_s and its influence on L_s is shown in formula 3:

$$L_s = (\mu_o \times \mu_r \times N_s^2 \times I_m)/A \quad (3)$$

where $\mu_o = 4\pi \times 10^{-7}$, N_s is the number of turns of the secondary winding, A is the cross-sectional surface area of the core in square meters, and I_m is the mean length, in meters, of the magnetic path of the field lines in the core.

In an output transformer, all the quantities in formula 3 are constant except for μ_r . Because μ_r represents the "movability" of the magnetic particles in the core, an investigation of that movability explains the deviation from linearity.

At core saturation, all the Weissareas are pointing in the same direction and cannot move further into a better position. Consequently, μ_r becomes almost zero. At very low magnetization, the magnetic force between Weissareas keeps them more or less stationary, so μ_r again is not very large (initial permeability). Somewhere in between these extremes, the ability to move and

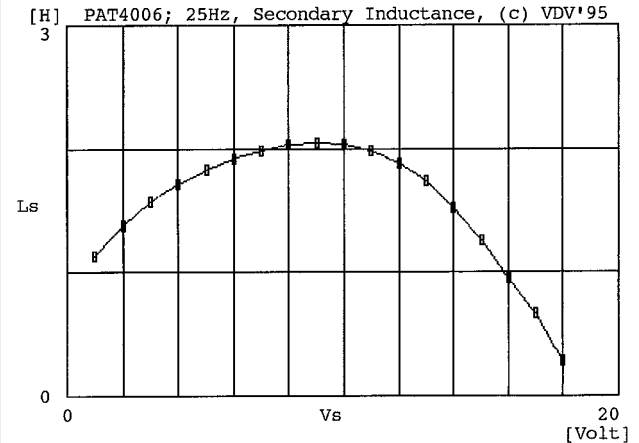

FIGURE 6: Secondary inductance as a function of v_s .

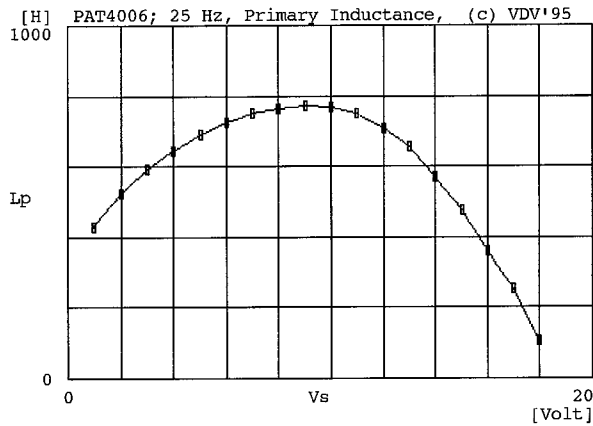

FIGURE 7: Primary inductance as a function of v_s .

to react will be optimal, and there μ_r will reach its maximum value. This behavior explains Figs. 6 and 7.

Imagine now that this variable movement is the main reason why primary sound energy from the power tubes can be converted into secondary energy at the loudspeakers. It then becomes clear that OPTs can be “difficult” devices. Their behavior seems far from linear, which might cause a lot of distortion.

Compare this to tubes, where the anode current obeys strict and simple laws, or to transistors, where pure logarithmic relations exist. Those are very clean devices compared to OPTs. So why not throw those OPTs away? Because they are not really as bad as they seem, and they do sound nice. I shall explain why this is so by looking at their distortion behavior.

TABLE 1

OPT SAMPLES USED

1. Copland
2. Dynaco ST-70
3. Dynaco MK III
4. Luxman MQ-360
5. Luxman MQ-80
6. Plitron PAT4006

Calculating OPT Distortion

To learn the procedure for calculating OPT distortion, consider a push-pull power amplifier, a standard circuit for which is shown in Fig. 8. Each of the power tubes has an effective plate resistance, r_p . The secondary side of the OPT is connected to a loudspeaker with impedance Z_L . Suppose Z_L is frequency-independent and constant. On the primary side of the OPT, Z_L is expressed by R_{aa} , which is almost $2k\Omega$ for the PAT4006. Figure 9 shows the low-frequency equivalent circuit of this amplifier, seen from the primary side of the OPT.

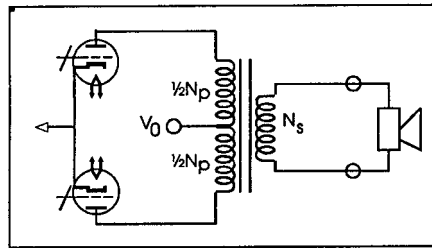

FIGURE 8: Standard push-pull circuit.

The two power tubes are replaced by a voltage source with a series resistor equal to $2 \times r_p$. (In this discussion, I omit the resistances of the primary and secondary windings, since their influence on the distortion is minimal.) Imagine now that this amplifier starts working. An alternating voltage, v_{aa} , will appear between the two anodes and generate an alternating current in the circuit of Fig. 9.

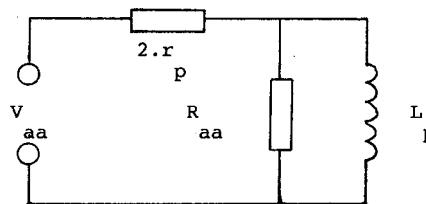

FIGURE 9: Low-frequency equivalent circuit.

The current passing the primary inductance L_p generates a magnetic field in the core, resulting in a voltage at the secondary side of the OPT. It is now easy to understand that distortion might occur. Because L_p is not constant, the current becomes distorted. However, will the secondary voltage show the same distortion?

This distortion phenomenon was researched by Partridge.⁴ Figure 10 shows an example of his measurement results with cores made of 3.5% silicon steel.⁵ On the vertical axis the current distortion ID is shown in percentages, while the horizontal axis gives the amplitude of the magnetic flux density B_{max} [Tesla] in that core. (The flux density is the number of magnetic-field lines per square meter crossing a surface A.) The three characteristics given are the second, third, and fifth harmonics in the current distortion.

To explain the distortion behavior of an OPT in general, I now assume that the sample transformers of Fig. 2 use the core material as shown in Fig. 10. The secondary voltage, v_s , can be converted into B_{max} by using formula 4:

$$B_{max} = v_s \times \frac{\sqrt{2}}{N_s \times 2\pi f A} \quad (4)$$

Partridge derived the following formula for calculating the voltage distortion VD (in %):

$$VD = ID \times \frac{R_{eq}}{2\pi f L_p} = \left(1 - \frac{R_{eq}}{4 \times 2\pi f L_p} \right) \quad (5)$$

The resistance R_{eq} is given by:

$$R_{eq} = \frac{R_{aa} \times 2r_p}{R_{aa} + 2r_p} \quad (6)$$

Now you have all the information you need to calculate the voltage distortion at any frequency and any secondary voltage, assuming core materials as indicated in Fig. 10.



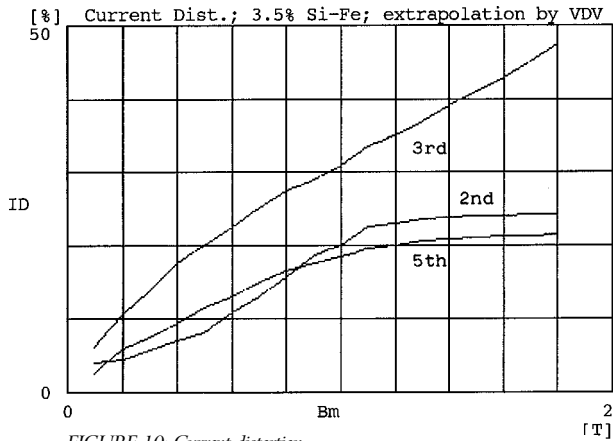

FIGURE 10: Current distortion.

Influence of Tubes on Distortion

I used the procedure of the last section to calculate the distortion in the PAT4006 sample when driven by four 6550WA Sovtek tubes. Two are paralleled on the upper side of the OPT primary and the other two on the lower side. In pentode mode, the effective plate resistance is equal to $7.5k\Omega$, and in ultralinear mode (screen grids to 40% taps on the primary) the effective plate resistance is almost $2k\Omega$. In triode mode, the plate resistance equals 750Ω . The calculated

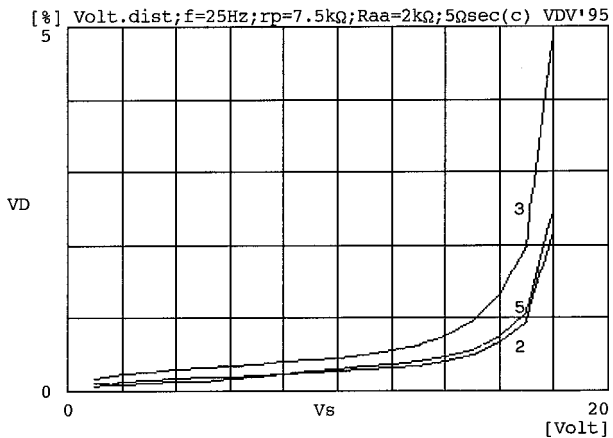

FIGURE 11: Voltage distortion at 25Hz, pentode mode.

distortion for these three modes is shown in Figs. 11, 12, and 13, respectively.

The general rule drawn from these calculations is that the smaller the effective plate resistance, the smaller the distortion. In Hodgson's article⁵, he uses this argument to explain why triodes sound better than pentodes. Based on these calculations, I find that the OPT distortion is less in the triode mode, and I agree with his line of thinking.

Another situation (Fig. 14) shows the distortion when the frequency is 50Hz instead of 25Hz. The tubes are in ultralinear mode. The distortion is much smaller in comparison to the 25Hz calculation. In general, the higher the frequency, the smaller the distortion caused by the core. I will show later that this effect is important in explaining the specific sound character of a tube amplifier.

The next exercise with these calculations is found in Fig. 15. There I assumed the current on the PAT sample to be ten times larger than in Fig. 2, with the net result that the effective inductance is ten times smaller. The increase in distortion is striking when compared to the previous situations. This explains why a large L_p value is of the utmost importance in creating an undistorted sound at low frequencies.

How Bad Is Alinearity?

You can discern a striking similarity in all the distortion characteristics given above. The variation in μ_r is not visible in these graphs, nor does the alinearity in L_p or L_s seem to be an important factor. It appears as though the alinearity is cancelled out of the voltage-distortion equations. Only at the saturation limit, where L_p and L_s are very small, is the voltage distortion large. This is an unexpected result. How to understand it?

It can easily be proven mathematically that below saturation, the voltage distortion will be small and nearly independent of the μ_r behavior, as long as the condition of formula 7 is met:

$$2\pi f L_p \gg R_{eq} \quad (7)$$

A large primary inductance is therefore absolutely essential to make the distortion as small as possible at low frequencies, because only then will this condition be met. The moment $2\pi f L_p$ equals or approximates R_{eq} , the distortion behavior becomes very sensitive to variations in μ_r . An example of this is shown in Fig. 15, where L_p was made ten times smaller. Hence, OPTs with large inductances—and consequently small currents when measured by Berglund's method—are a condition for small voltage-distortion figures.

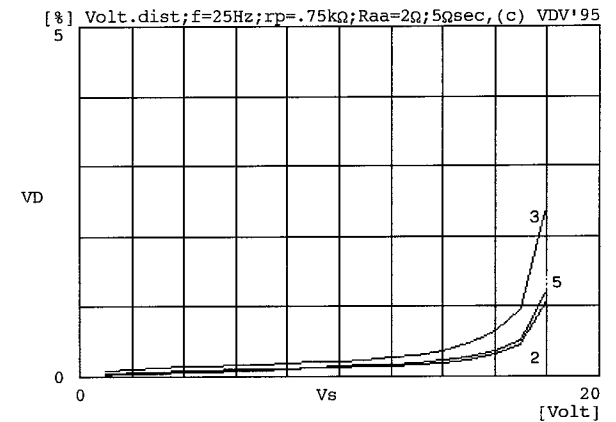

FIGURE 13: Voltage distortion at 25Hz, triode mode.

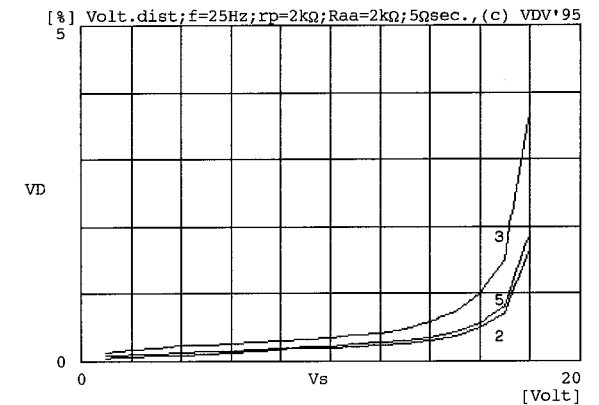

FIGURE 12: Voltage distortion at 25Hz, ultralinear mode.

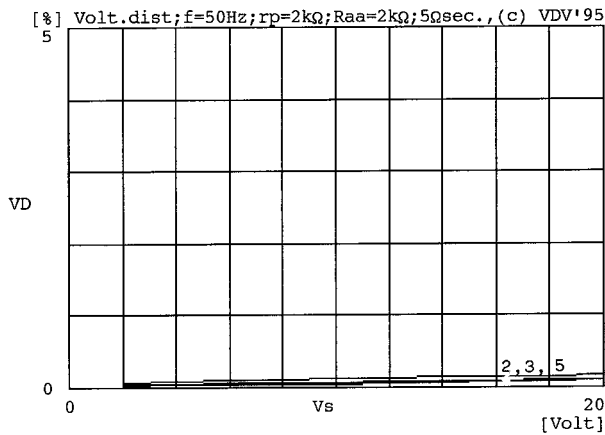

FIGURE 14: Voltage distortion at 50Hz, ultralinear mode.

However, it can become necessary to design transformers with small primary inductances. This is the case in single-ended types, where you must create a balance between DC and AC saturation, resulting in a much smaller L_p than in the push-pull situation. The condition of formula 7 will not be met, so it is absolutely necessary to provide a constant μ_r behavior to prevent the voltage distortion from becoming very large. You can realize

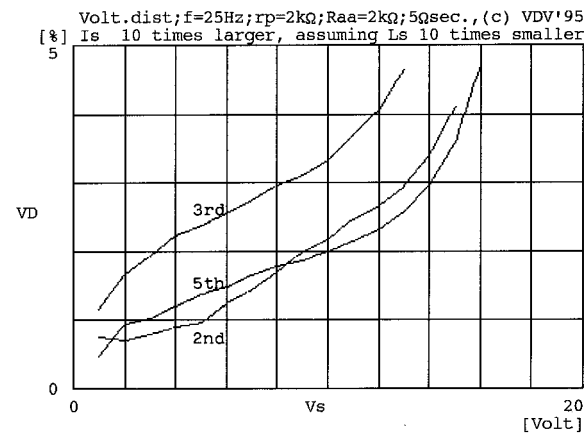

FIGURE 15: Voltage distortion with L_p ten times smaller.

constant μ_r behavior by choosing special core materials and by fine-tuning the air gaps.

What is the final result of this research? I have added the condition of formula 7 to Berglund's test method. This condition is important in judging whether an OPT is good or bad in a certain application. Therefore, you cannot judge the quality of an OPT on its specifications alone. You can best determine the usefulness of an OPT when the conditions of application are formulated. This means: R_{eq} and the lowest frequency f should be compared to the primary inductance L_p . Only then can you determine whether or not optimal use is being made of an OPT.

OPT Sound: Bass Response

I have gathered a lot of information to explain the specific sound character of tube amplifiers. First I will focus on the specific bass sound of a tube amplifier. Especially at low frequencies, OPT distortion becomes dominant over that of the tube circuitry. The condition of formula 7 indicates the frequency below which this OPT voltage distortion becomes crucial.

An OPT with tubes whose distortion becomes large below 40Hz will generate a second harmonic of 80Hz, a third harmonic of 120Hz, and so on. These harmonics are closely related to the 40Hz fundamental. When you listen to such an amplifier, you hear a rich and strong bass, but not the distortion as a separate component.

What you hear testifies to the amazing ability of our ears to convert harmonic components into fundamentals. We keep hearing 40Hz, and due to the harmonics, this tone sounds stronger and louder. Tests have been conducted⁶ in which the fundamental was removed and only the harmonics were present. They showed that the fundamental was actually heard while not present. So the harmonic components strongly support the fundamental.

This creation of harmonic components occurs only at low frequencies, while the midband and high-frequency spectrum stay undistorted. Therefore this distortion does not sound harsh

or nasty, but is fully acceptable to our ears. The conclusion is that this specific OPT distortion enriches the reproduced sound, especially at low frequencies.

But what happens when you use an OPT with very large inductance? It might surprise you, but the bass will sound *softer*. No distortion components are produced, and you hear only the clear bass tone. This can be explained with reference to the PAT4006.

During tests I noticed that this toroidal's bass sounded softer than that of an EI-core OPT with low primary inductance (30H). Due to its large L_p value, the toroidal OPT's frequency range to the low end was more extended than that of the EI-core OPT. The bass should therefore have sounded louder with the toroidal OPT. But this was not the case, and the above theory explains this behavior. I leave it to you to decide whether or not extra low-bass harmonics are welcome.

This bass-distortion theory clarifies why OPTs can sound completely different in varying circumstances. It explains why OPTs in guitar amplifiers play a major role in creating a special tonal balance. It makes clear that oversized cores should not be used in guitar amps because the warm sound character of low primary-inductance transformers is a major tool in creating the specific guitar sound. This model also explains why you find huge cores in sophisticated high-end equipment. They are there to keep the low-frequency distortion as small as possible. In all this, toroidal OPTs follow their own laws.

OPT Sound: the Damping Factor

In the forthcoming discussion of the broad-bandwidth interaction between a loudspeaker and a tube amplifier, I will assume that the latter is used without overall negative feedback. I further assume that there is no such thing as a loudspeaker with a constant frequency-independent impedance. Imagine now a tube amplifier with perfect frequency, distortion, and time behavior.



This “perfect” amp can cause a special effect when connected to a speaker with a frequency-dependent impedance. I do not mean that the amp will begin to oscillate. I refer to a totally different effect, which has been studied in the past and is still very important. *Figure 16* shows the equivalent circuit of the tube amplifier and the loudspeaker Z_L .

The amplifier has output impedance Z_{out} , defined in formula 8:

$$Z_{out} = \left(\frac{N_s}{N_p} \right)^2 \times (2r_p + R_{ip}) + R_{is} \quad (8)$$

Due to the perfect wide bandwidth of the amplifier and the absence of overall negative feedback, this output impedance will be frequency-independent. Suppose the amplifier amplifies A times and the input signal is v_{input} . Then the output voltage v_{out} at the speaker terminals is given by formula 9:

$$v_{out} = v_{input} \times A \times \frac{Z_L}{Z_L + Z_{out}} = v_{input} \times A \times \frac{\frac{Z_L}{Z_{out}}}{\frac{Z_L}{Z_{out}} + 1} = v_{input} \times A \times \frac{DF}{DF + 1}$$

In this formula, the damping factor is defined as $DF = Z_L/Z_{out}$. Amplifier specifications usually assume a constant speaker impedance of 8Ω , so that a damping factor of 4 results in an output impedance of 2Ω .

In real life, however, because the speaker impedance varies with frequency, the actual damping factor will not be constant. Therefore, as formula 9 makes clear, the output voltage at the speaker terminals will vary with the frequency.

Most speakers, however, are designed to receive a constant frequency-independent voltage at their terminals, and consequently will deliver a

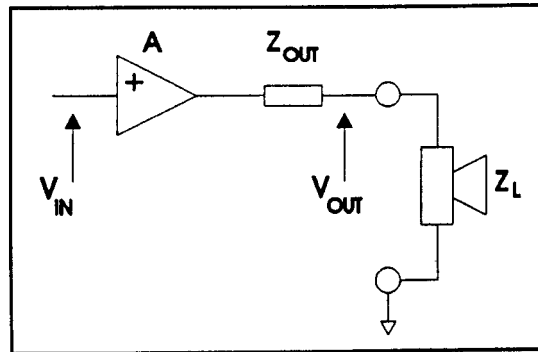

FIGURE 16: Amplifier with output impedance Z_{out} , connected to a loudspeaker.

constant, frequency-independent sound pressure level (SPL) on axis. But this will not be true of a tube amp with a low damping factor.

Adjustable Damping Factor

To investigate this effect, I built an amp with an adjustable damping factor and connected it to a magneto dynamic speaker. I set the damping factor at 100, 8, 4, 2, and 1 (referred to 8Ω).

I measured the SPL with a calibrated microphone on axis under dead room conditions. The characteristic with damping factor = 100 was chosen as the reference, so all the other measurements show the deviation to this condition. The results are shown in *Fig. 17*.

The results are amazing! The smaller the damping factor, the larger the deviation from a constant frequency characteristic. Tube amplifiers without feedback especially have low damping factors, ranging from 1 to 2, and under those conditions a rather large high-frequency rolloff occurs. I repeated these

measurements with several speakers, and they all showed this tendency.

However, listening tests with these speakers did not show large subjective differences when the damping factor changed from 100 to 1. Why do I not detect these changes in the frequency response? I am not the only one, because tube amps with little or no overall negative feedback are now in use all over the world, and I hear no complaints about high-frequency rolloff. My explanation is that human hearing quickly adapts to changes in the frequency response, as long as those changes are not very abrupt. But there is more going on.

Research by Kirk⁷ has shown that after an adaptation period, restricted high-frequency sound reproduction is preferred over full-range reproduction. Most of the currently available tube amps have damping factors below 16, and therefore will show more or less high-frequency rolloff. This rolloff seems to be more satisfactory than a full range sound—up to 22kHz in modern CD sound reproduction with high-damping-factor amplifiers.

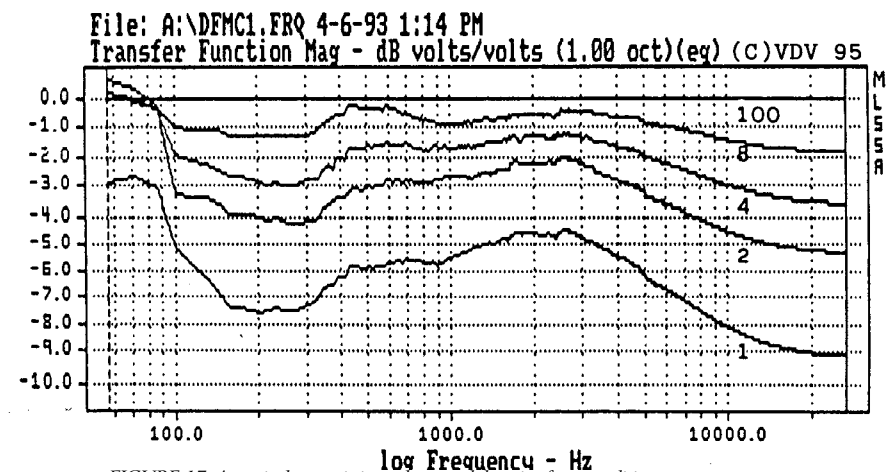

FIGURE 17: Acoustic characteristics under several damping-factor conditions.

Passing the Digital Frontier

As a reviewer for a Dutch high-end magazine, I have performed many listening tests with the best amplifiers, speakers, and CD players available all over the world. All these systems sounded magnificent, but eventually I developed a preference for tube amps and their specific sound character. I built and designed a great many tube amps with almost any frequency range, distortion behavior, and damping factor you can imagine. I ended up adopting damping factors around 4, and so far am very satisfied with the results.

Recently, however, I received a double-sampling-speed DAT recorder (Pioneer D-07). Its sampling frequency can be set at 32, 48, or 96kHz, creating an effective signal bandwidth of 16, 24, or 48kHz, respectively. I used it to make many recordings in the three sampling modes with excellent mikes. I evaluated the subjective results and discovered a remarkable effect.

The recordings with an effective bandwidth up to 16kHz sounded very natural and true. Recordings up to 24kHz made me, my wife, and my friends ask what was wrong with the amplifier and the speakers. However, recordings made with a frequency range up to 48kHz were absolutely tops—fresh, very natural, mild, and soft.

Brain-Wave Research

These subjective results are closely related to recent scientific research in which human alpha-brain-wave activity was measured while the subjects were listening to recorded Gamelan music of Bali. This was done with a restricted frequency range (up to 26kHz) and with a broad bandwidth up to 48kHz.⁸ Advanced detectors were able to measure alpha waves in the brain generated by the Gamelan music. These electrical brain waves have a frequency of about 8Hz, and when present they indicate the subject is enjoying a pleasant feeling.

With full bandwidth reproduction, however, the alpha brain waves were much more strongly present than with the frequency-restricted

26kHz reproduction. It was clear that the listeners subjectively preferred the 48kHz bandwidth reproduction and were able to distinguish between the two modes. The researchers concluded that we are able somehow to detect the presence of high-frequency sound above the upper hearing limit of 20kHz, and to convert this high-frequency part into alpha waves.

My experiences add some facts to this remarkable research. I found that the sound character is very good when we record in a bandwidth of 16kHz, but going up to a bandwidth of 22kHz does not make the sound quality better—harsh components seem to enter the recording. However, recordings within a 48kHz bandwidth sound magnificent, showing none of these harsh effects.

A prudent conclusion might be that the frequency range between an estimated 16 and 22kHz seems to generate a harsh and “grindy” sound character, whereas with the information up to 48kHz, the harsh character disappears.

These results strongly relate to tube-amp behavior. As discussed previously, tube amps without overall negative feedback reproduce acoustically up to 16kHz when the damping factor is low. Consequently, we receive less of the harsh and “grindy” sound, as I described it. Tube amps *with* feedback have a higher damping factor and reproduce full strength up to 22kHz. I have often heard people say they prefer no-feedback designs, and in the light of the acoustical reproduction of frequencies between 16kHz and 24kHz, this is understandable.

The logical consequence should be: don't change the concept of tube amps. Leave them alone, because they adapt to our hearing preference. My answer to this would be “yes and no.” The yes is easy to understand. The explanation of the no follows.

Digital Developments and the Tube Answer

Recently a miracle took place. The new high-density video disc (HDVD) was accepted worldwide as the new recording and

reproduction medium for video. This HDVD also offers very advanced possibilities for optimal sound recording and reproduction, and therefore a number of important audio people have formed the Acoustic Renaissance for Audio (ARA). Their aim is to make optimal audio use of this new technology. They will initiate proposals and new recommendations for using the HDVD as a high-quality audio disc (HQAD).

For example, on this disc you could place 24-bit recordings with a sampling frequency of 44.1kHz, or up to six channels with advanced ambient field information. Another possibility is a high 96kHz digital-sampling frequency. This means that the future digital-audio frequency range can be extended up to 48kHz. Then we would be able to use the full capabilities of our ears, including alpha-brain-wave effects.

When this happens, the amplifier/ speaker combination must be able to reproduce this frequency range without any restriction. Consequently, new tweeters should be designed for loudspeakers. But what does this mean for modern tube amplifiers? They must then have a very wide frequency and power bandwidth, greatly exceeding 40kHz—even under open-loop conditions so as to prevent time- and frequency-related distortion. They must also have a high damping factor to prevent high-frequency rolloff as indicated above.

The large bandwidth requires special tube circuitry and special wide-bandwidth OPTs. The large damping factor needs special feedback circuitry, which can be done with substantial overall negative feedback, or by means of local feedback around the amplifier's power stage. On the basis of calculations and listening tests, I prefer the latter solution.



References

1. Rickard Berglund, "Quick, Simple Output Transformer Tests," *GA* 1/95, pp. 24, 49.
2. Menno van der Veen, "Theory and Practice of Wide Bandwidth Toroidal Output Transformers," AES preprint #3887 (G-2), 97th Convention, November 10–13, 1994, San Francisco, CA.
3. Menno van der Veen, *Transformers and Tubes in Power Amplifiers*, Plitron Manufacturing Inc., 250 Wildcat Rd., Downsview, ON M3J 2N5, Canada.
4. N. Partridge, "Distortion in Transformer Cores," *Wireless World*, June 22/29 and July 6/13, 1939.
5. Tom Hodgson, "Single-Ended Amplifiers, Feedback and Horns: Some History," *Sound Practices*, Spring 1994, pp. 39–42.
6. "Auditory Demonstrations," IPO, NIU, ASA; Philips CD1126-061; demonstration 20, "Virtual Pitch," track 37.
7. R. E. Kirk, "Learning, a Major Factor Influencing Preferences in High Fidelity Reproducing Systems," *JAES* 1957, 5(4), pp. 238–241.
8. Tsutomu, Oohashi et al, "High-Frequency Sound Above the Audible Range Affects Brain Electrical Activity and Sound Perception," AES preprint 3207 (W-1), 91st Convention, October 4–8, 1991, New York.